

rk steel smith
defining workspace



INDUSTRIAL LOCKER

PRODUCT RANGE

2018



Industrial Lockers

03 to 17

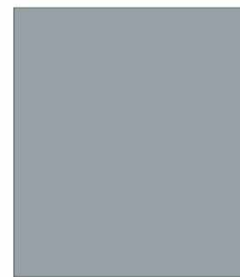
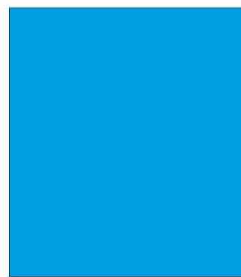
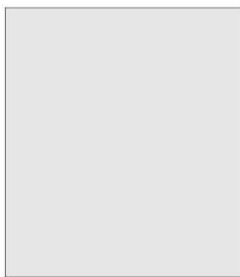

Colour Option

18

We are the manufacturer of Industrial Lockers with different size and dimensions, We have given details of our regular Industrial lockers. These lockers are available with 3-lockers, 6-lockers, 9-lockers, 12-lockers, 15-lockers, 18-lockers etc having ventilating louvers, arrangement for padlocking or built-in lock. These are widely used in factories, hospitals, clubs, water parks etc.

**18 Gauge (1.2mm thk.)
Construction**

3no. Compartment



Each compartment
305W. X 500D. X1800H.

915mm Wide
500mm Depth
1980mm Height

RK IND LOC-1850-01

**18 Gauge (1.2mm thk.)
Construction**

6no. Compartment



Each compartment
305W. X 500D. X900H.

915mm Wide
500mm Depth
1980mm Height

RK IND LOC-1850-02

**18 Gauge (1.2mm thk.)
Construction**

9no. Compartment



Each compartment
305W. X 500D. X600H.

500mm Depth
1980mm Height

RK IND LOC-1850-03

Minimum order qty. - 15no.

We are the manufacturer of Industrial Lockers with different size and dimensions, We have given details of our regular Industrial lockers. These lockers are available with 3-lockers, 6-lockers, 9-lockers, 12-lockers, 15-lockers, 18-lockers etc having ventilating louvers, arrangement for padlocking or built-in lock. These are widely used in factories, hospitals, clubs, water parks etc.

**18 Gauge (1.2mm thk.)
Construction**

12no. Compartment



Each compartment
305W. X 500D. X450H.

915mm Wide
500mm Depth
1980mm Height

RK IND LOC-1850-04

**18 Gauge (1.2mm thk.)
Construction**

15no. Compartment



Each compartment
305W. X 500D. X360H.

915mm Wide
500mm Depth
1980mm Height

RK IND LOC-1850-05

**18 Gauge (1.2mm thk.)
Construction**

18no. Compartment



Each compartment
305W. X 500D. X305H.

915mm Wide
500mm Depth
1980mm Height

RK IND LOC-1850-06

Minimum order qty. - 15no.

**18 Gauge (1.2mm thk.)
Construction**

**3no. Compartment
with double door**



**Each compartment
900W. X 500D. X550H.**

**03no.
compartment**

RK IND LOC-1850-07

**18 Gauge (1.2mm thk.)
Construction**

**4no. Compartment
with double door**



**Each compartment
900W. X 500D. X400H.**

**04no.
compartment**

RK IND LOC-1850-08

**18 Gauge (1.2mm thk.)
Construction**

**5no. Compartment
with double door**



**Each compartment
900W. X 500D. X325H.**

**05no.
compartment**

RK IND LOC-1850-08

Product Number

(Width X Depth X Height)

**Number of
compartments**

RK IND LOC-1850-07

900mm X 500mm X 1850mm

3

Minimum order qty. - 05no.

RK IND LOC-1850-08

900mm X 500mm X 1850mm

4

Minimum order qty. - 05no.

RK IND LOC-1850-09

900mm X 500mm X 1850mm

5

Minimum order qty. - 05no.





Made entirely of steel, cell phone lockers can be surface mounted or recessed mounted and can accommodate cell phones, keys, tablet PC's, it equipment notebook, wallets, cameras, e-readers, smart devices and other valuable items.



The cabinets must be secured to the floor or to the wall.

Product Number	(Width X Depth X Height)	Number of compartments
RK IND LOC-1850-10	900mm X 300mm X 1850mm	30 (250mm W. X 275mm D. X 150mm H. each compt.)
RK IND LOC-1850-11	900mm X 300mm X 1850mm	40 (175mm W. X 275mm D. X 150mm H. each compt.)
RK IND LOC-1850-12	900mm X 300mm X 1850mm with stand	15 (250mm W. X 275mm D. X 150mm H. each compt.)
RK IND LOC-1850-13	900mm X 300mm X 1850mm with stand	20 (175mm W. X 275mm D. X 150mm H. each compt.)

CABINET ARE AVAILABLE

POWERED **NON-POWERED**



Made entirely of steel, cell phone lockers can be surface mounted or recessed mounted and can accommodate cell phones, keys, tablet PC's, it equipment notebook, wallets, cameras, e-readers, smart devices and other valuable items.

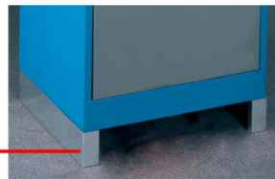

Example of using the pair of base plinths.



Product Number **(Width X Depth X Height)**

RK IND LOC-1850-14

900mm X 500mm X 1850mm

Number of compartments

20 (400mm W. X 475mm D. X 150mm H. each compt.)

RK IND LOC-1850-15

900mm X 500mm X 1850mm

14 (400mm W. X 475mm D. X 225mm H. each compt.)



RK IND LOC-1850-16



RK IND LOC-1850-17

- If you need secure, visible storage for equipment, tools, inventory, or other valuable items
- Visibility Lockers are an excellent option
- 4mm welded wire with 50mm X 50mm spacing, on a sturdy 14 gauge square pipe frame
- Single unit consists of 1 vertical locker with 1 full height door
- Door features exclusive two-point locking system with concealed drop-rod, plus one padlock hasp (padlock not included)
- Solid roof. Floor attachment included



Product Number

(Width X Depth X Height)

Shelf

RK IND LOC-1850-16 **Single Door**

600mm X 500mm X 1850mm

2

Minimum order qty. - 05no.

RK IND LOC-1850-17 **Double Door**

900mm X 500mm X 1850mm

2

Minimum order qty. - 05no.

18 Gauge (1.2mm thk.) Housing & Door 14 Gauge (2.0mm thk.)

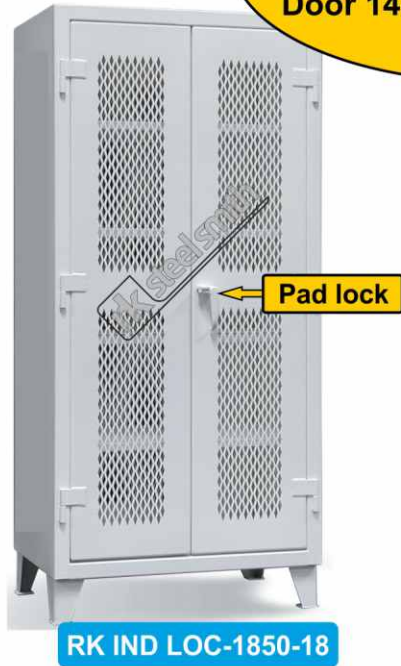

Our perforated door lockers are designed for situations where efficient ventilation and maximum visibility (**Housing & Door**) combined with security are essential.

- 1 and 6 door lockers fitted with security shelf to prevent unauthorised access to the compartment below
- Fitted with standard cam locks **OR** Pad lock
- Two tier lockers fitted with coat hook in each compartment
- Powder coated finish
- Standard 20mm sq. holes ■
- Also available in Diamond Perforated ◆

Product Number (Width X Depth X Height)

RK IND LOC-1850-18

900mm X 500mm X 1850mm

4 Shelf

RK IND LOC-1850-19

1200mm X 500mm X 1850mm

6 Compartments

This unit is great for gyms, locker rooms, schools and areas where personal locker storage is needed.

This unit features 6 compartments on the left side that measure 400mm wide x 850mm high.

This heavy duty locker is constructed from 14 gauge steel. 6 individual doors are equipped with a 2-point locking system.

Each door is ventilated.

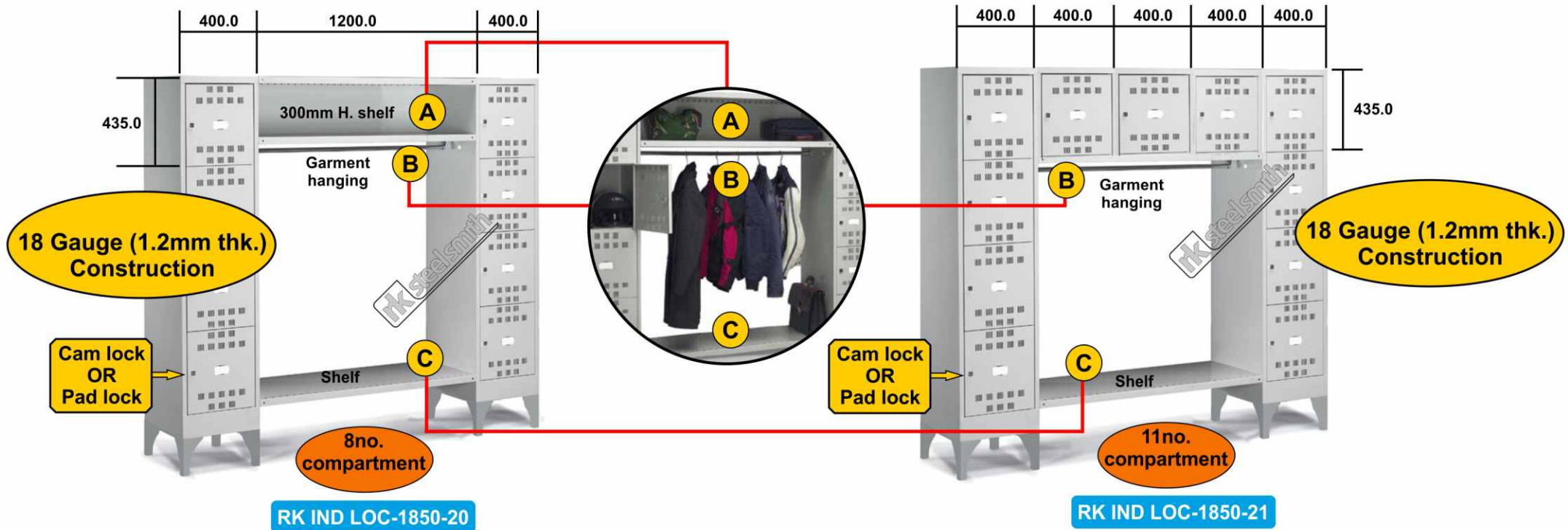

Product Number (Width X Depth X Height)

RK IND LOC-1850-20

2000 X 500mm X 1850mm

Number of compartments

8 (350mm W. X 475mm D. X 435mm H. each compartment)

RK IND LOC-1850-21

2000 X 500mm X 1850mm

11 (350mm W. X 475mm D. X 435mm H. each compartment)

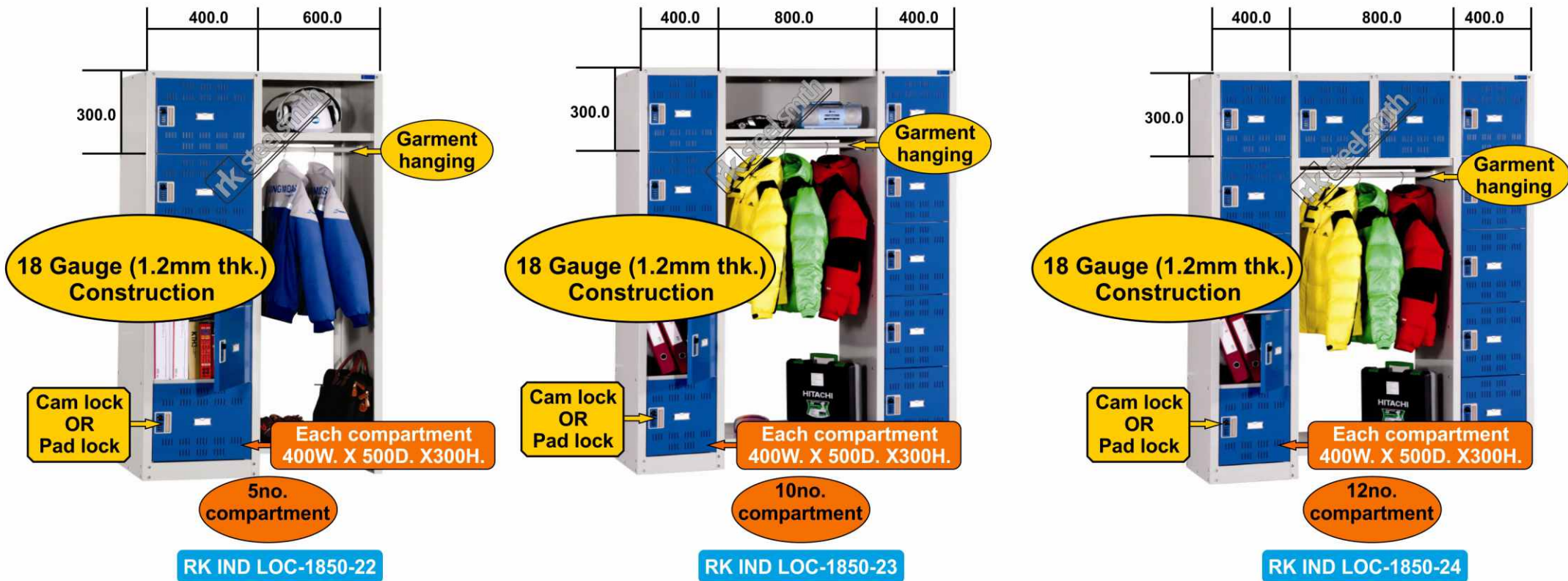

Product Number

(Width X Depth X Height)

Number of compartments

RK IND LOC-1850-22

1000 X 500mm X 1850mm

5 (350mm W. X 475mm D. X 300mm H. each compartment)

RK IND LOC-1850-23

1600 X 500mm X 1850mm

10 (350mm W. X 475mm D. X 300mm H. each compartment)

RK IND LOC-1850-24

1600 X 500mm X 1850mm

12 (350mm W. X 475mm D. X 300mm H. each compartment)

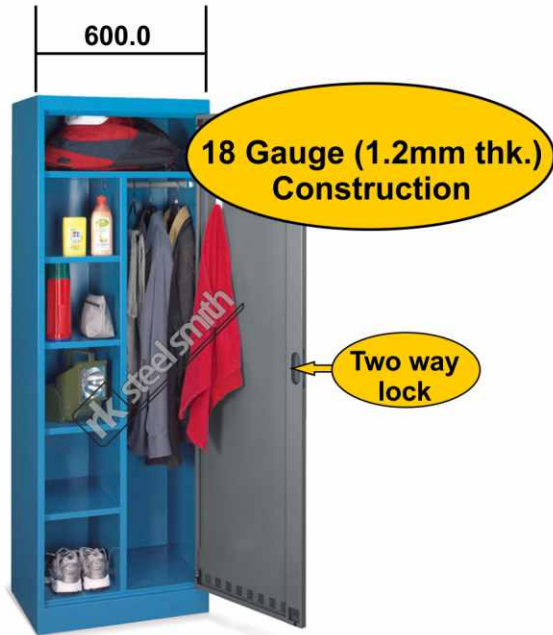

RK IND LOC-1850-25

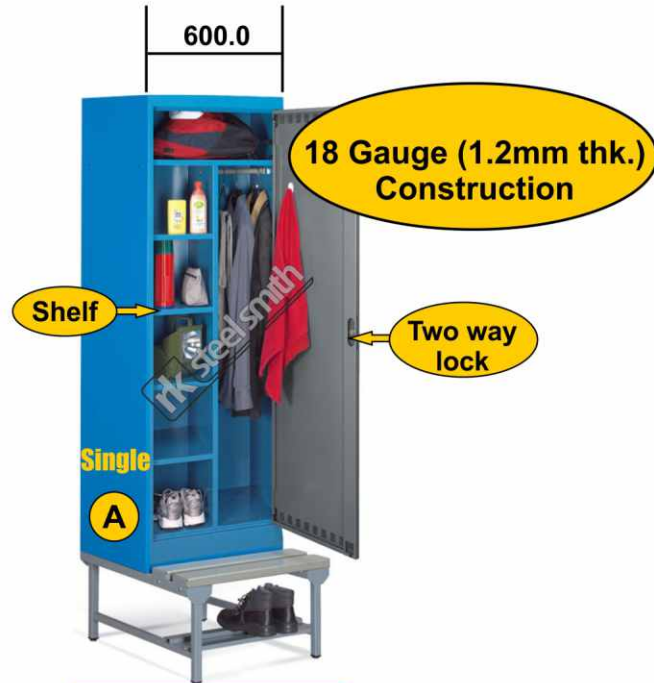

RK IND LOC-1850-26

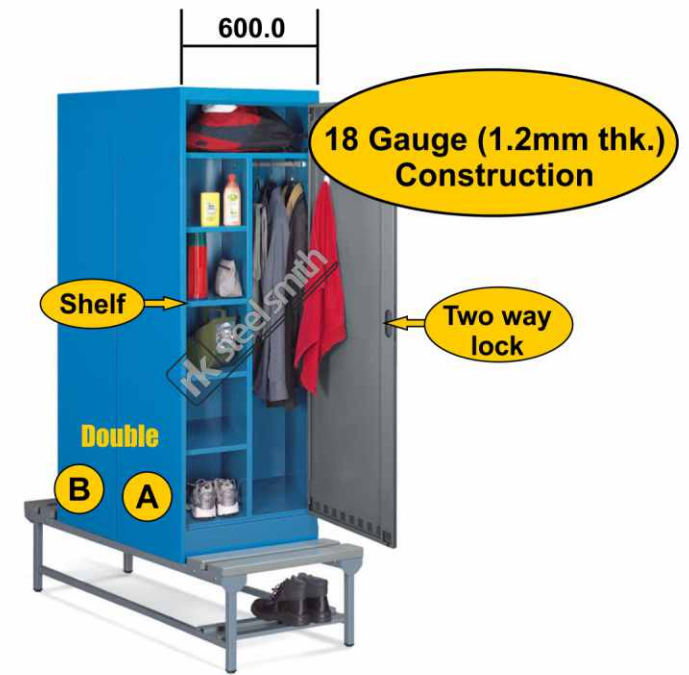

RK IND LOC-1850-27

Product Number

(Width X Depth X Height)

Shelf

RK IND LOC-1850-25

600mm X 500mm X 1850mm

5

RK IND LOC-1850-26

600mm X 500mm X 1500mm + 350mm Bench

4

RK IND LOC-1850-27 **Double**

600mm X 500mm X 1500mm + 350mm Bench

4

Single-sided bench



Solid bench made from welded tubular steel

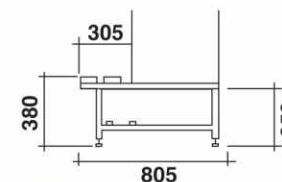

Depth of single-sided bench

Double-sided bench

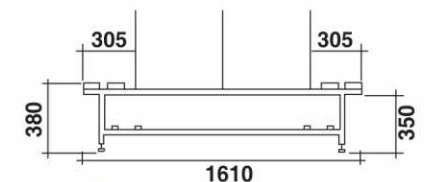

Depth of double-sided bench



Single-sided bench

Double-sided bench



Solid bench made from welded tubular steel

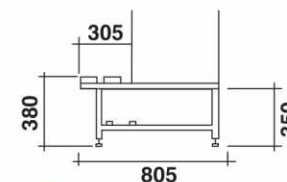

Depth of single-sided bench

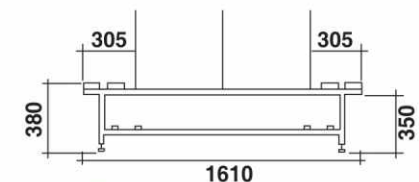

Depth of double-sided bench

Product Number	(Width X Depth X Height)	Shelf
RK IND LOC-1850-28	1200mm X 500mm X 1850mm	1
RK IND LOC-1850-29	1200mm X 500mm X 1500mm + 350mm Bench	1
RK IND LOC-1850-30 Double	1200mm X 500mm X 1500mm + 350mm Bench	1

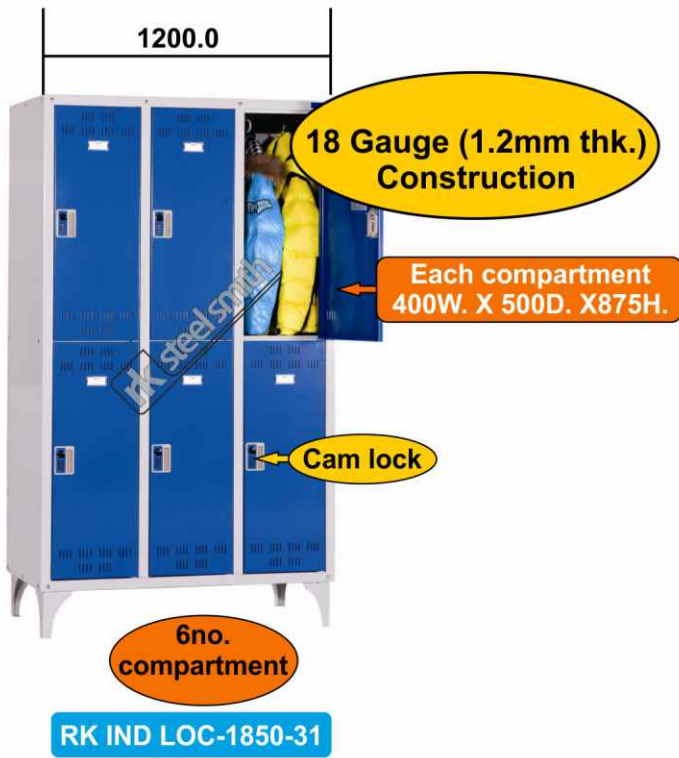

Single-sided bench

Double-sided bench



Solid bench made from welded tubular steel

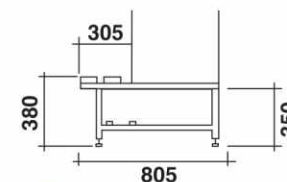

Depth of single-sided bench

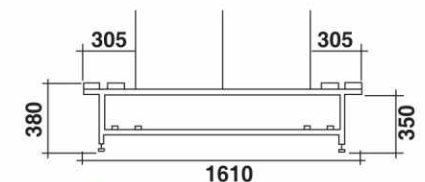

Depth of double-sided bench

Product Number	(Width X Depth X Height)
RK IND LOC-1850-31	1200mm X 500mm X 1850mm
RK IND LOC-1850-32	1200mm X 500mm X 1500mm + 350mm Bench
RK IND LOC-1850-33 Double	1200mm X 500mm X 1500mm + 350mm Bench

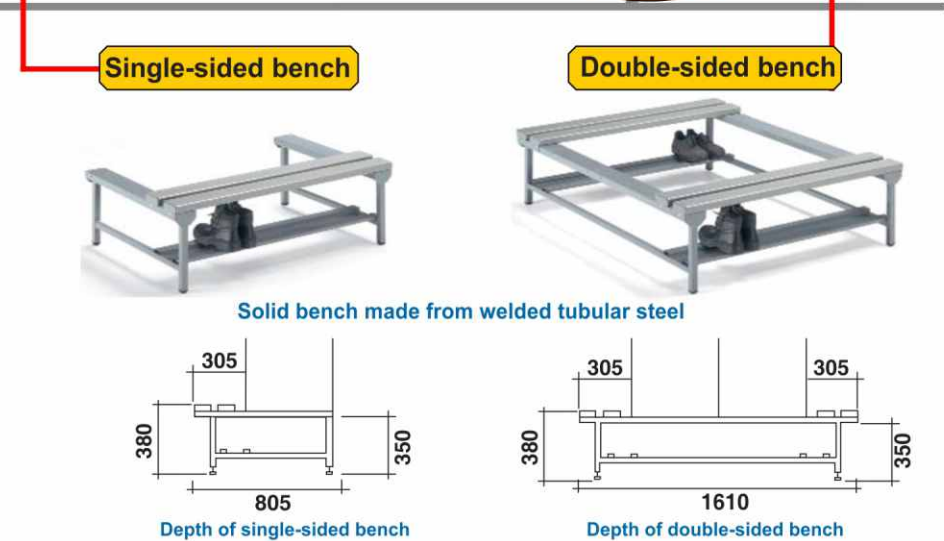
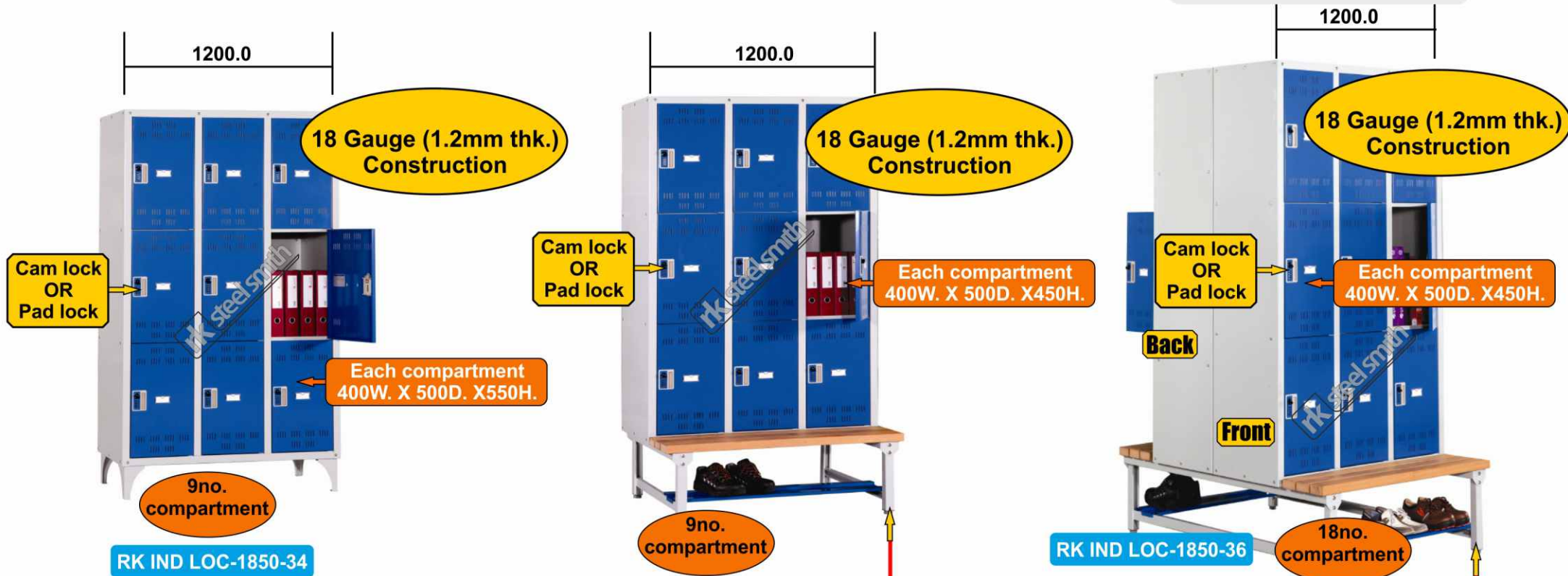

Product Number

(Width X Depth X Height)

RK IND LOC-1850-34

1200mm X 500mm X 1850mm

RK IND LOC-1850-35

1200mm X 500mm X 1500mm + 350mm Bench

RK IND LOC-1850-36

Double 1200mm X 500mm X 1500mm + 350mm Bench

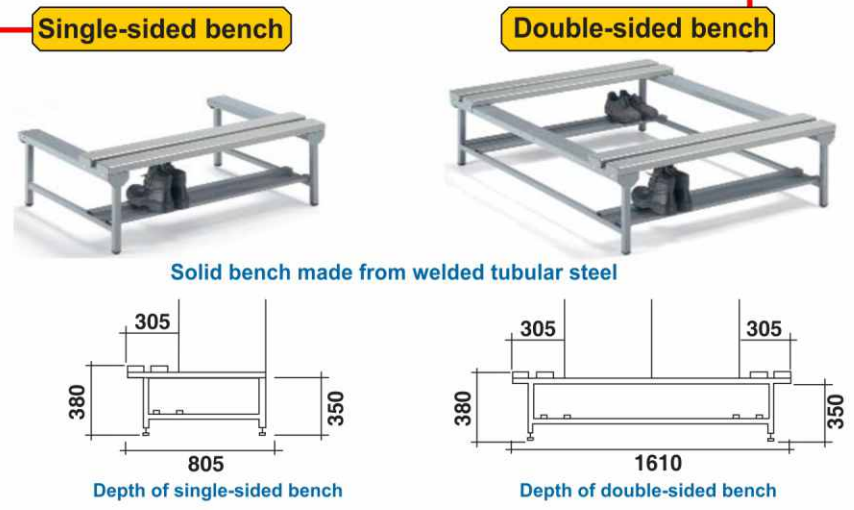
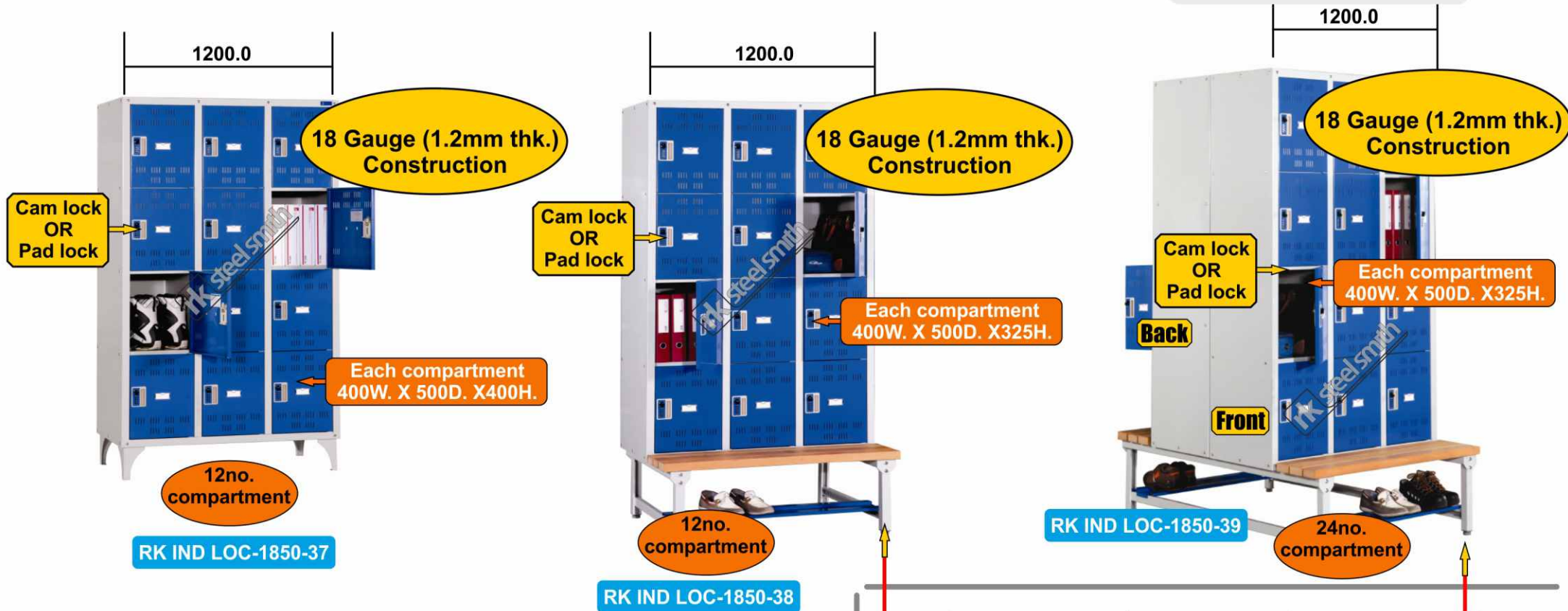

Product Number	(Width X Depth X Height)
RK IND LOC-1850-37	1200mm X 500mm X 1850mm
RK IND LOC-1850-38	1200mm X 500mm X 1500mm + 350mm Bench
RK IND LOC-1850-39 Double	1200mm X 500mm X 1500mm + 350mm Bench

GARMENT DISPENSERS

A single service door provides access to all the inner compartments of these Garment Dispensers enabling the distribution of clean garments, towels etc. Individual compartments remain secure and require keyed access.

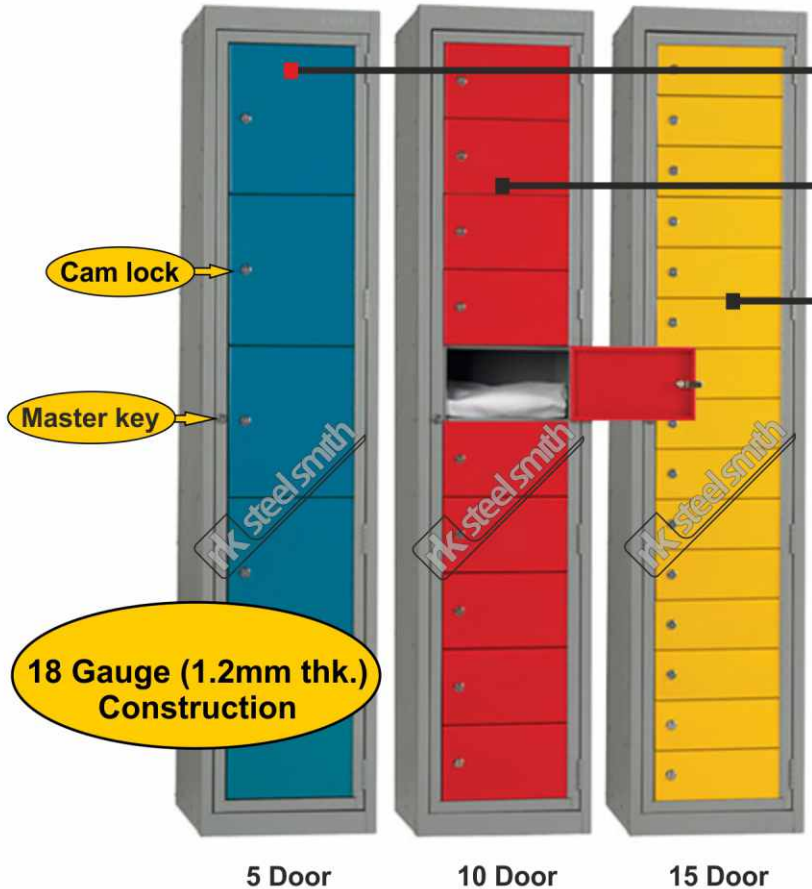

RK IND LOC-1850-40

RK IND LOC-1850-41

RK IND LOC-1850-42

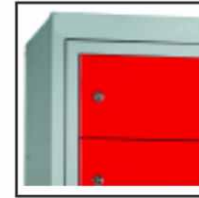

Double door frame



Master key
Master key access enabling quick refilling.

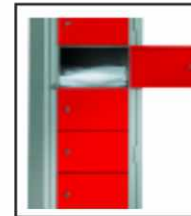

Compartment key
Separate compartment keys allowing secure independent access.

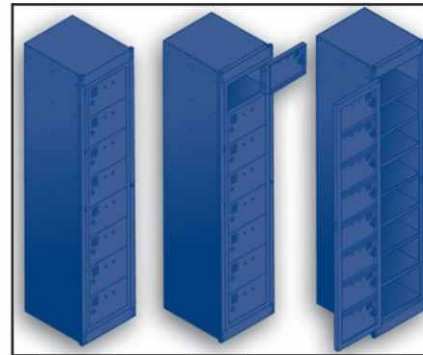

Garment Collector
This 'post box' style locker is for the collection of soiled garments.

Product Number (Width X Depth X Height)

RK IND LOC-1850-40

500mm X 500mm X 1850mm

RK IND LOC-1850-41

500mm X 500mm X 1850mm

RK IND LOC-1850-42

500mm X 500mm X 1850mm

Number of compartments

5 (450mm W. X 475mm D. X 300mm H. each compt.)

10 (450mm W. X 475mm D. X 150mm H. each compt.)

15 (450mm W. X 475mm D. X 100mm H. each compt.)

Standard Color option :



AMERICAN BLUE
STRUCTURE FINISH



7035 PALE GREY
STRUCTURE FINISH



DA GREY
STRUCTURE FINISH



PO RED
STRUCTURE FINISH

Assembled components are transfer to pre-treatment plant for treating in 7 tank for degrees, zinc, phosphating and passivation.

Material received from pre-treatment department are immediately powder coated in the dust free painting booth and then the articles are put inside a baking oven at a temperature of 180° C for about 20 minutes.



rk steel smith
defining workspace



Plot- B/32 (Part-2) Bileshwar Indl. Estate,
Opp. G.V.M.M.,
Odhav-Kathwada Road,
Ahmedabad - 382415
Gujarat (INDIA).



+91 94 281 35 100
+91 98 253 00 059



rksteelsmith@gmail.com
info@rksteelsmith.com
sales@rksteelsmith.com



www.rksteelsmith.com